

T1 (2x)

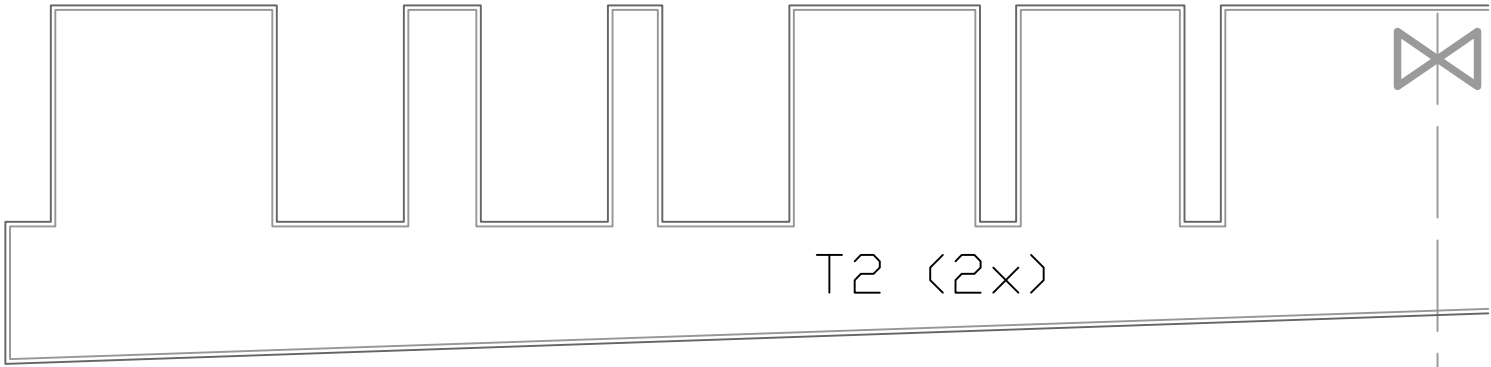

T2 (2x)



A2 (2x)

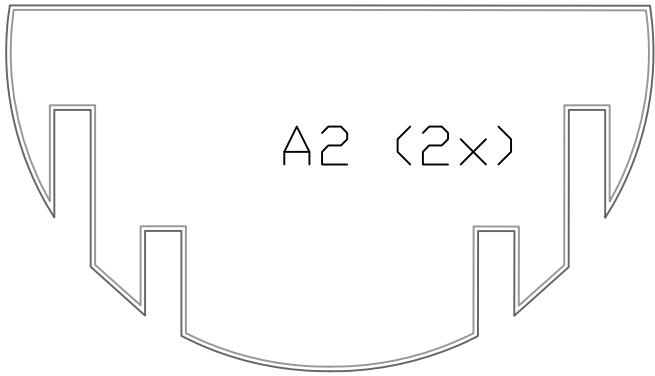

A1

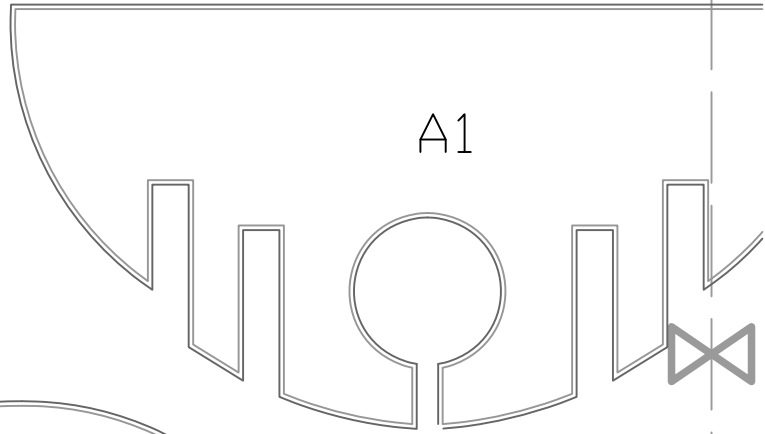

A3

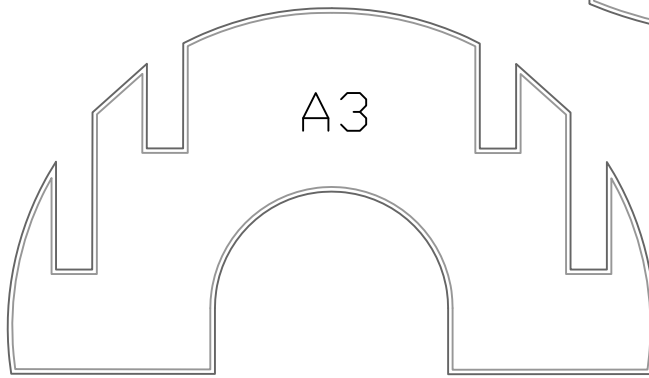

W1-C (2x)

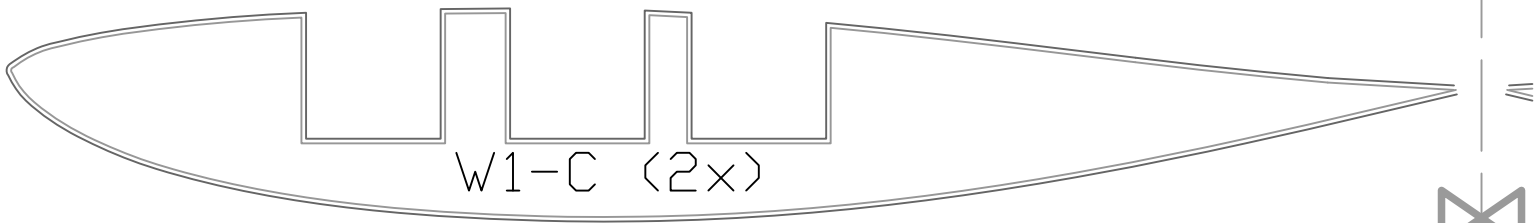

W1-D (2x)

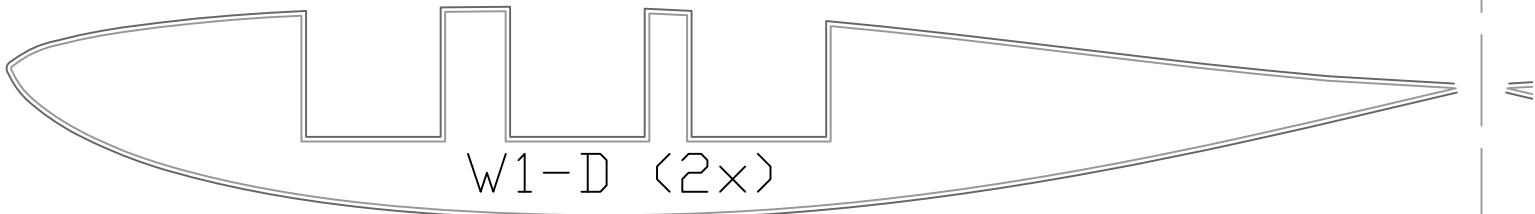

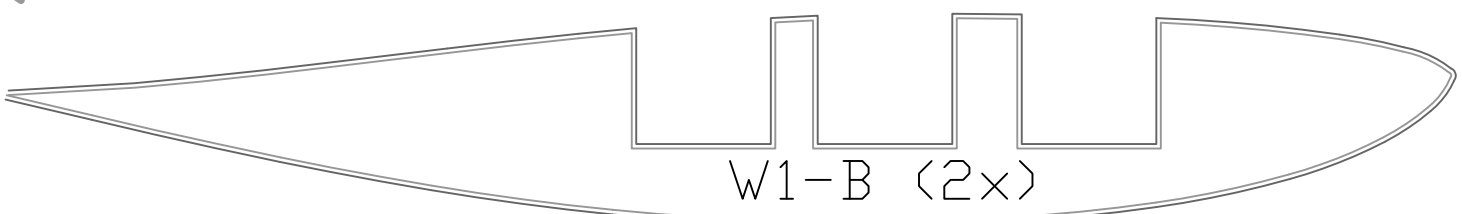
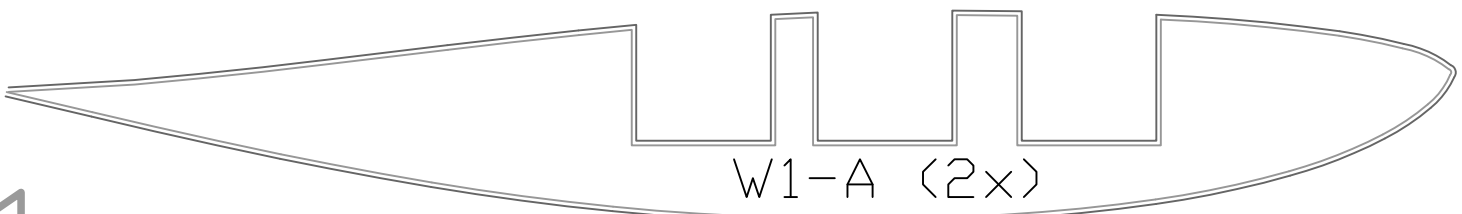
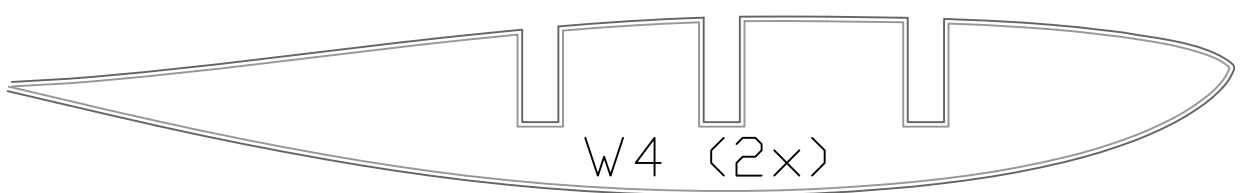
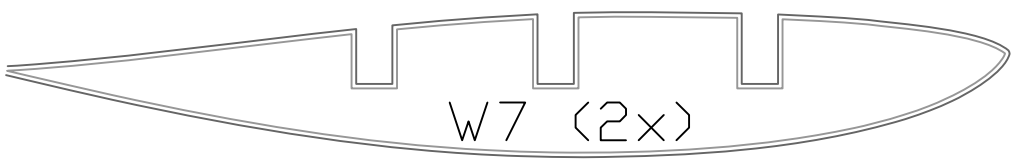
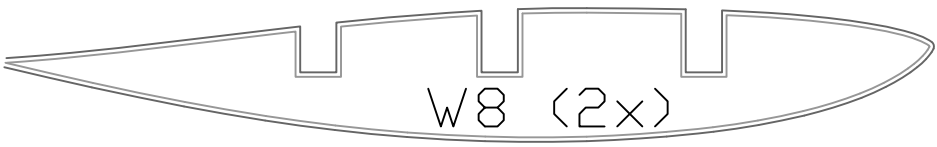

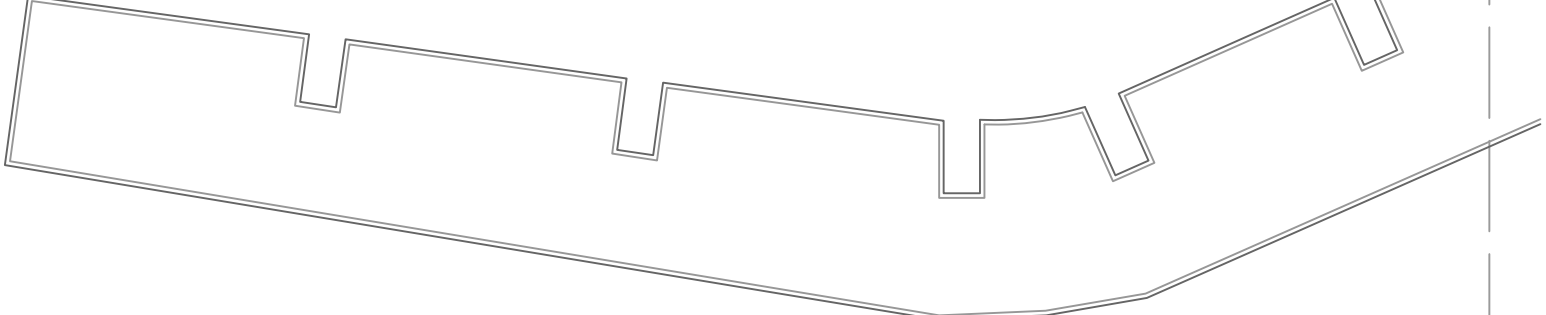
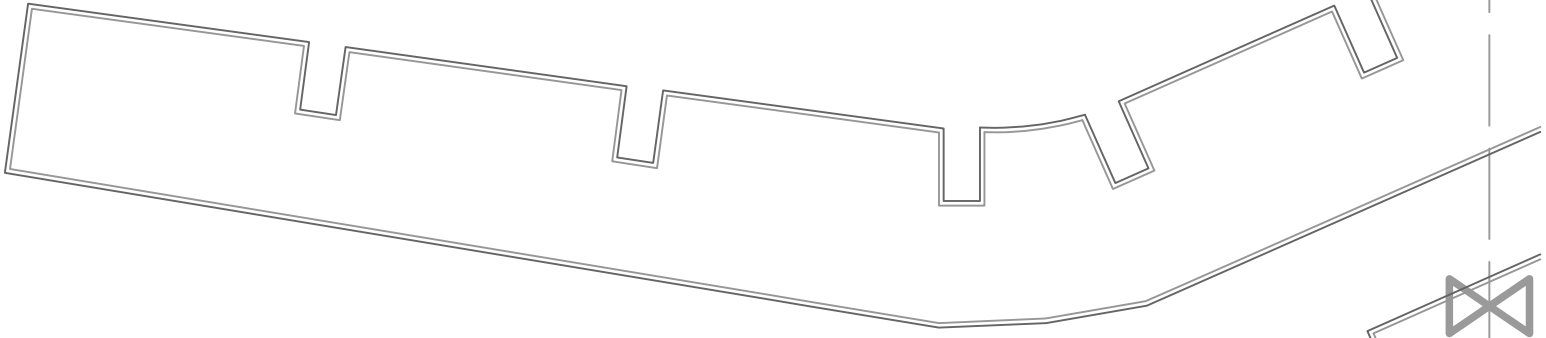
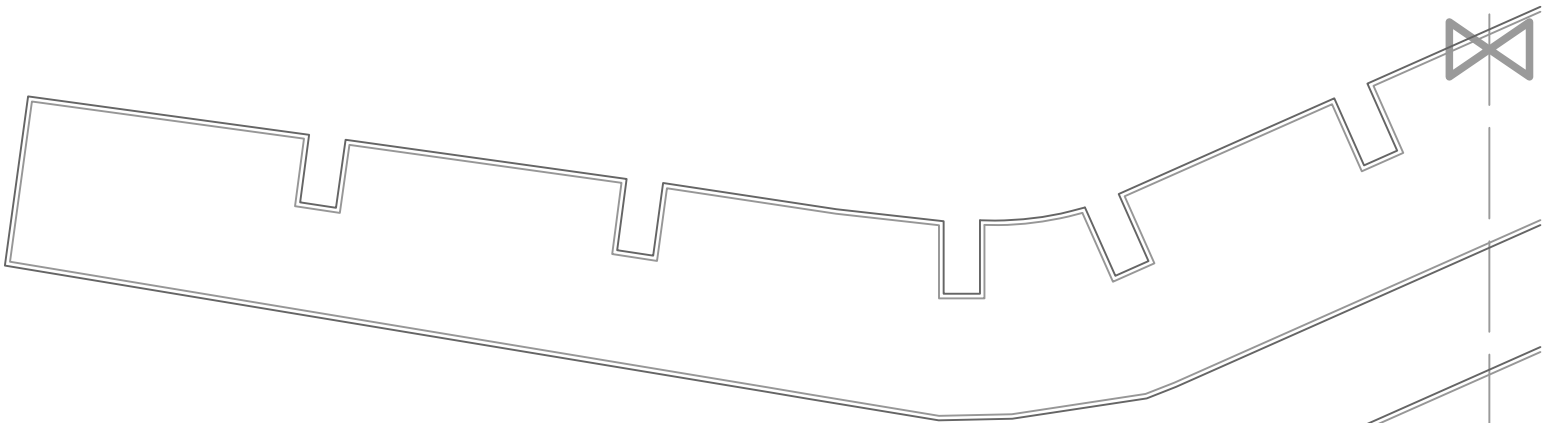
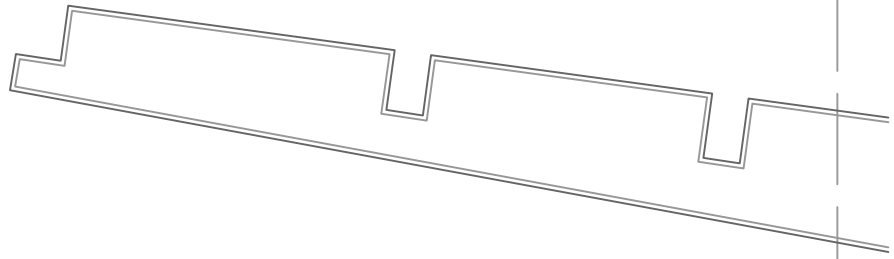
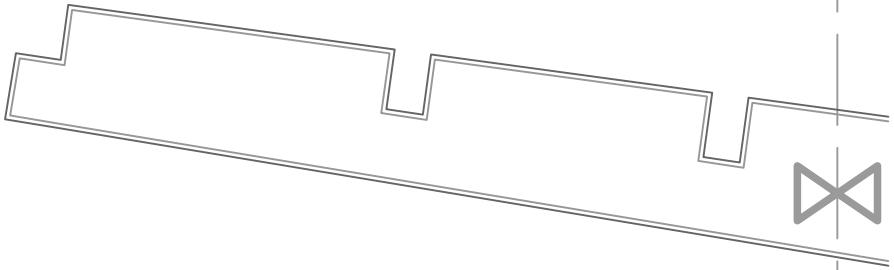
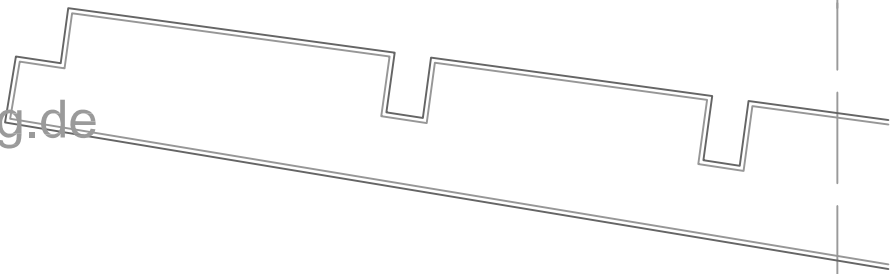

P1 (2x)

P2 (2x)

P3 (2x)

G1 (2x)

G2 (2x)

G3 (2x)



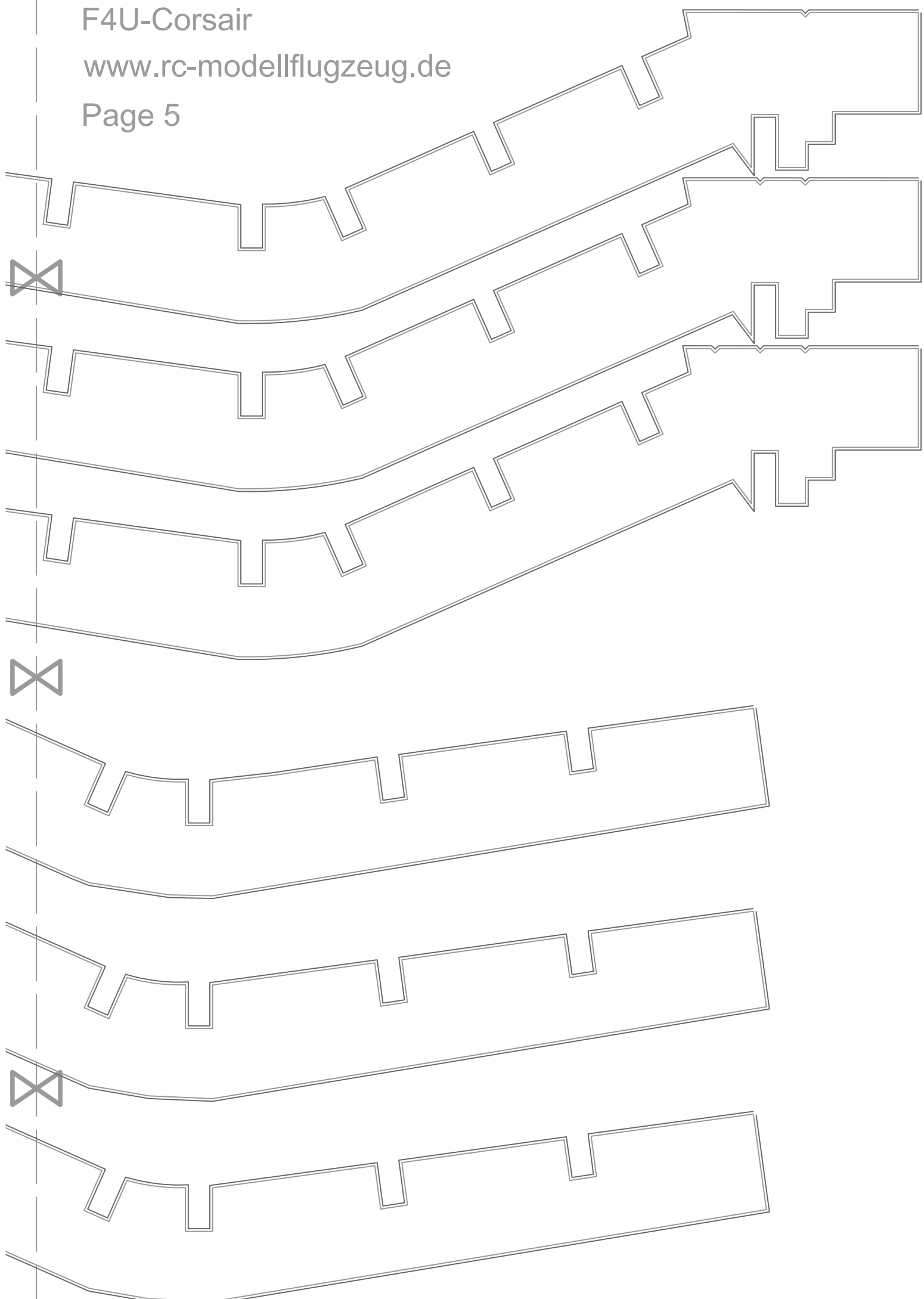

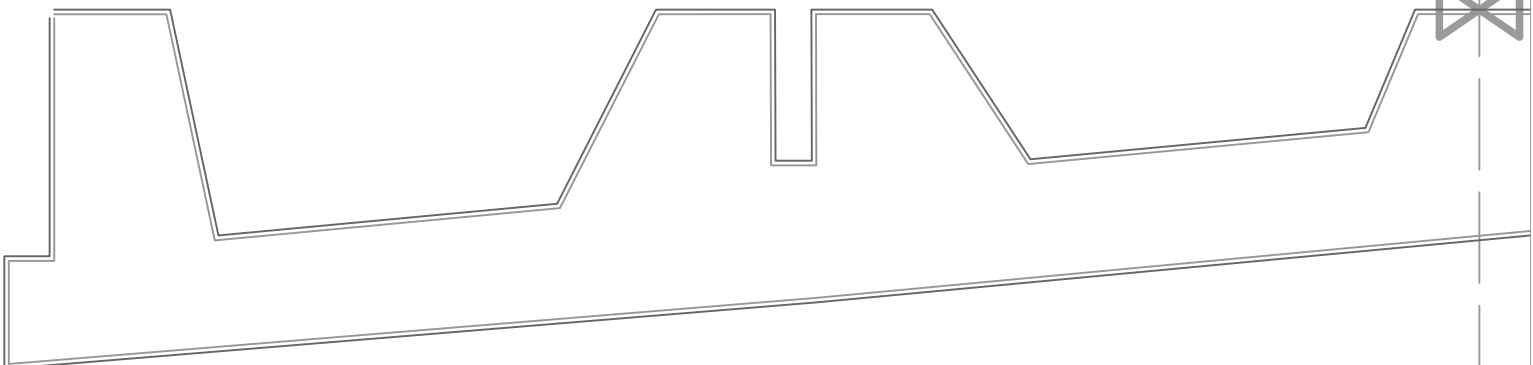
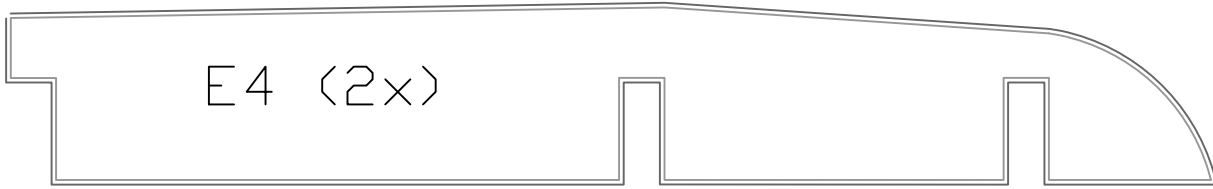
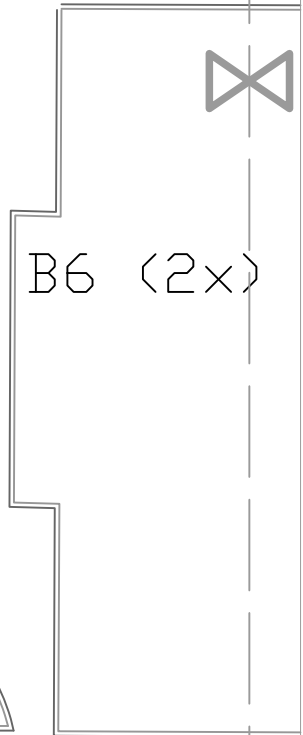
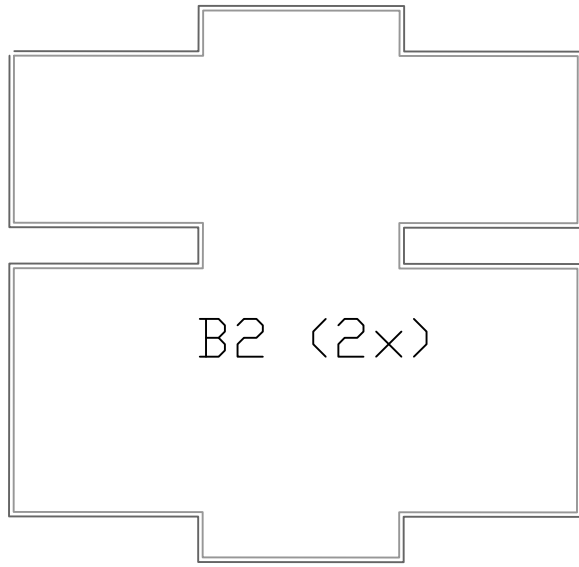
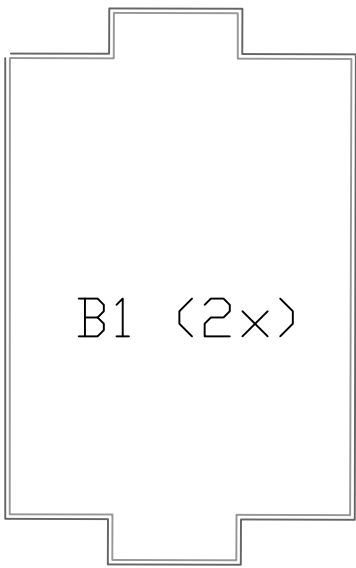
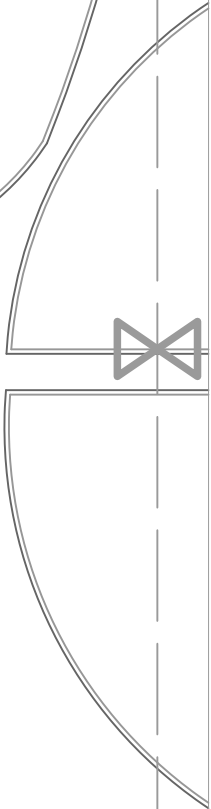
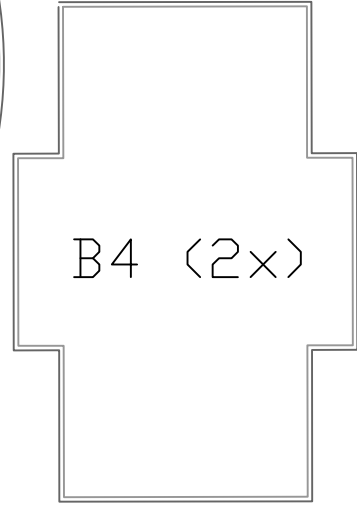
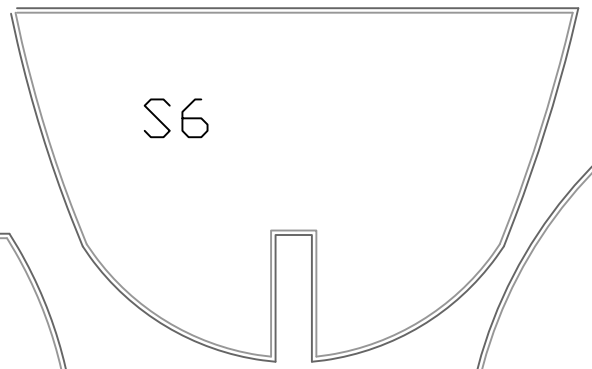
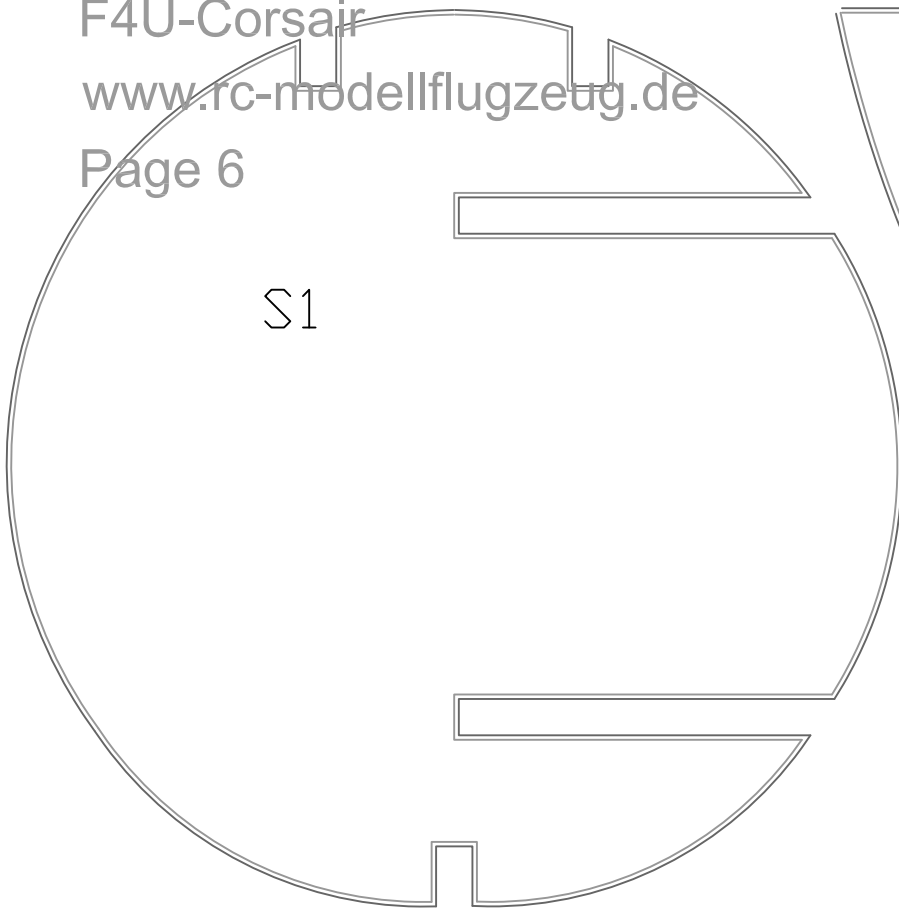

S2

B3 (2x)

B7 (2x)

B5 (2x)

R1 (2x)

E5 (2x)



x)

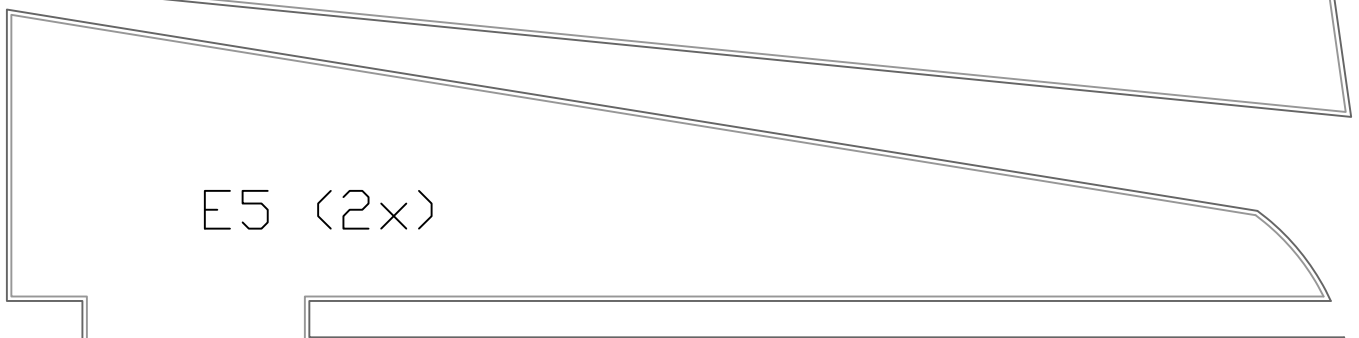
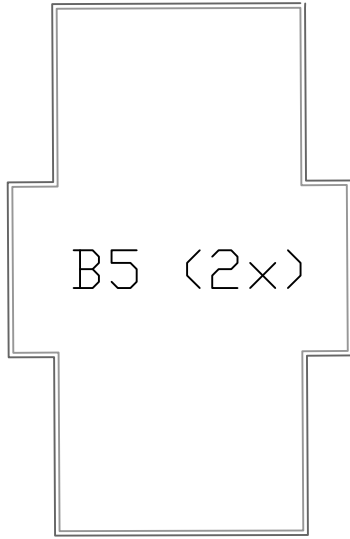
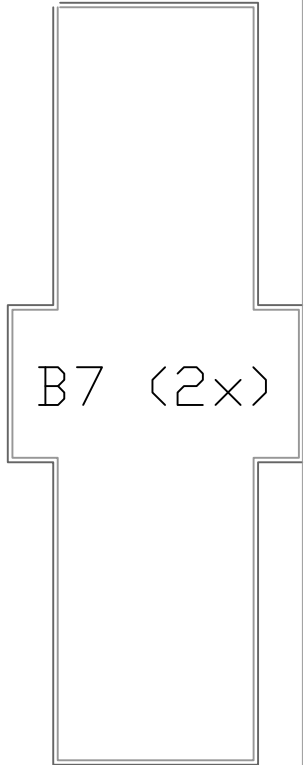
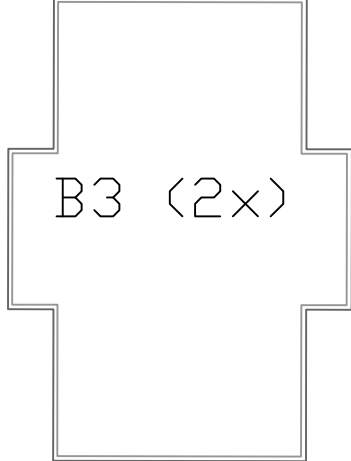
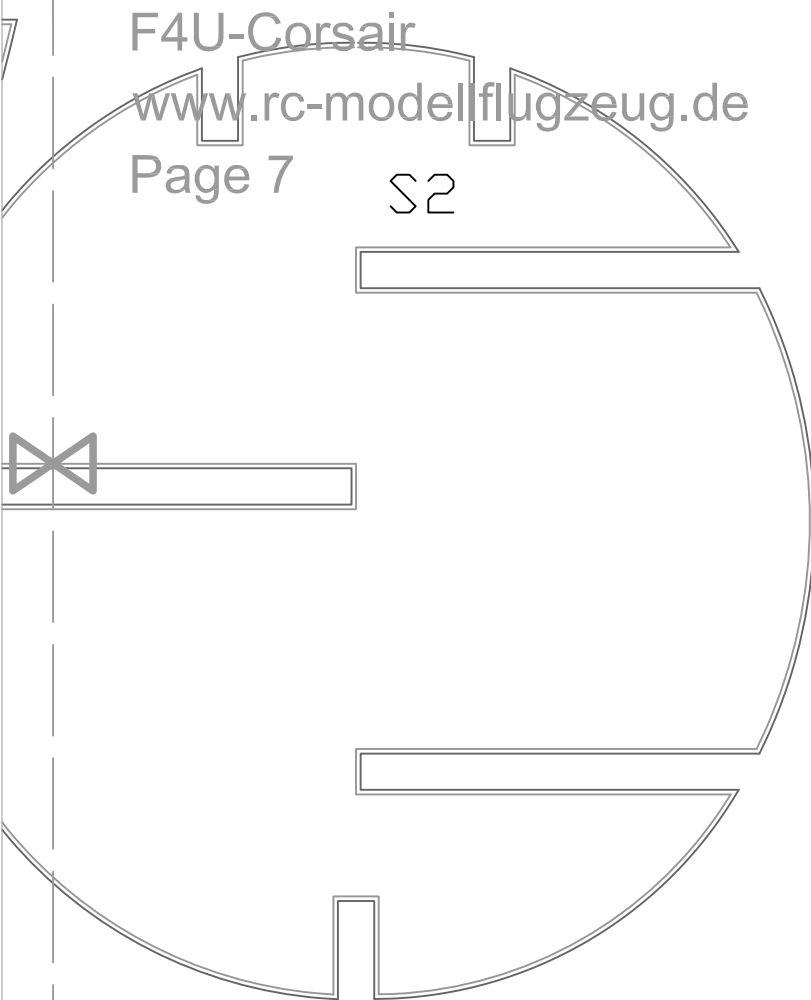

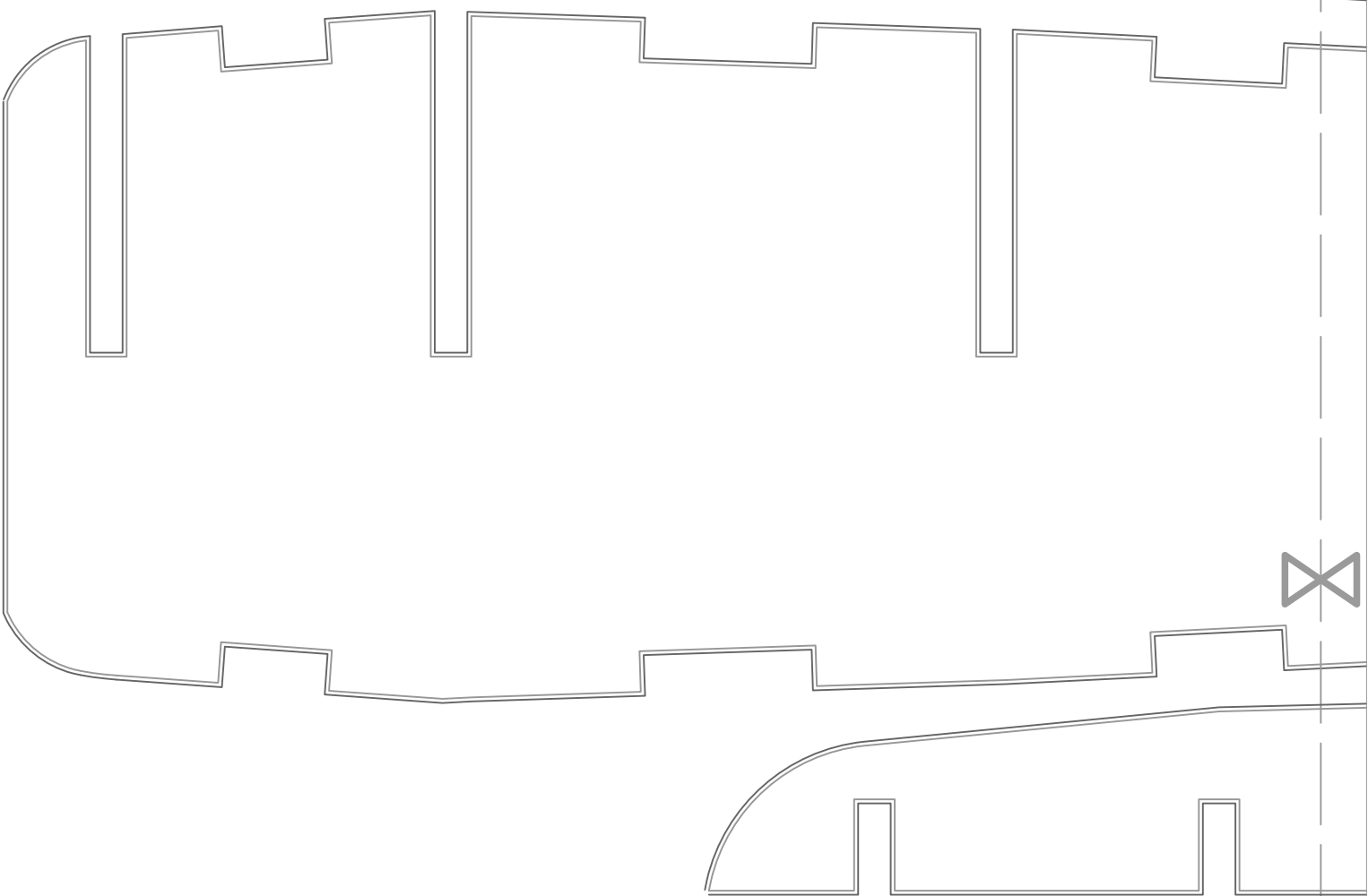
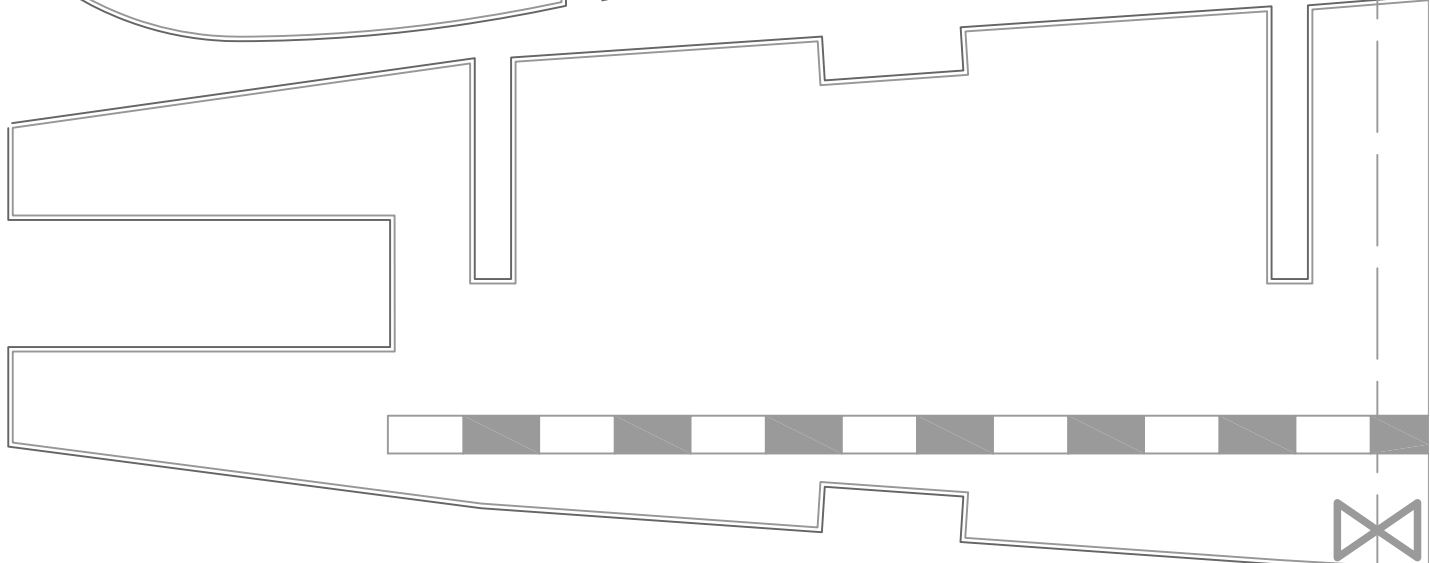
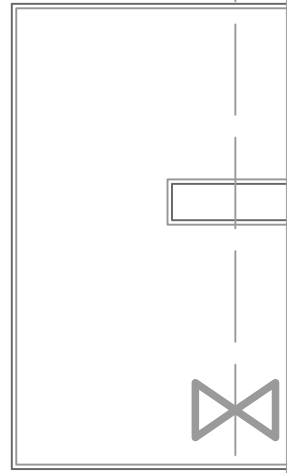
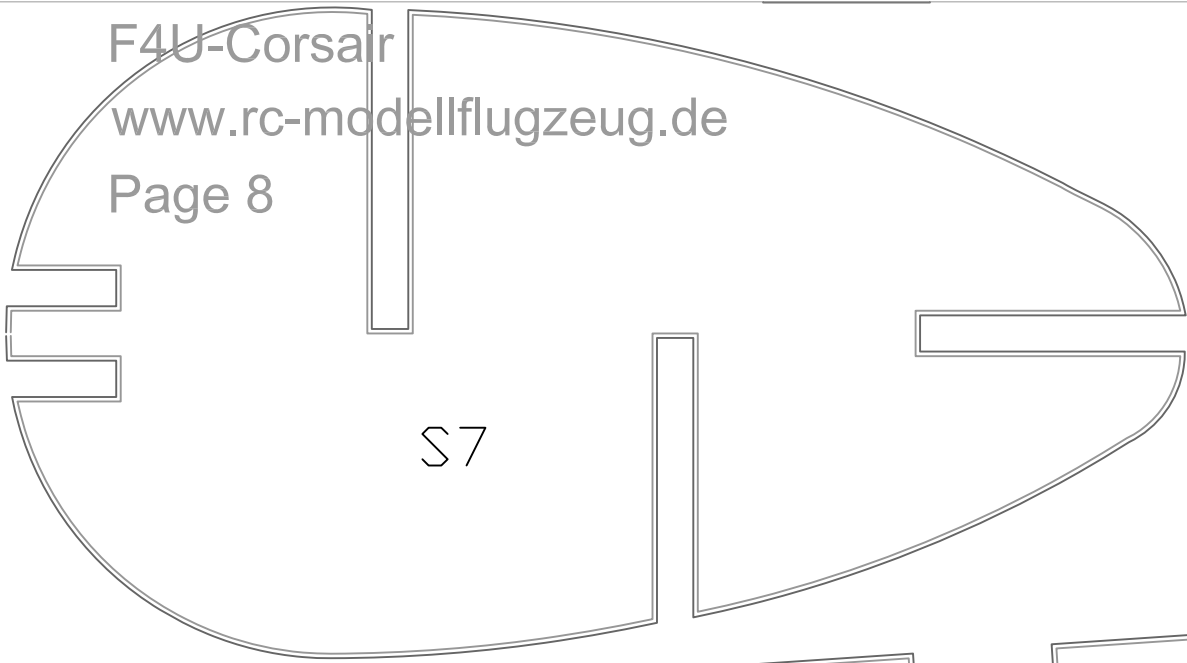

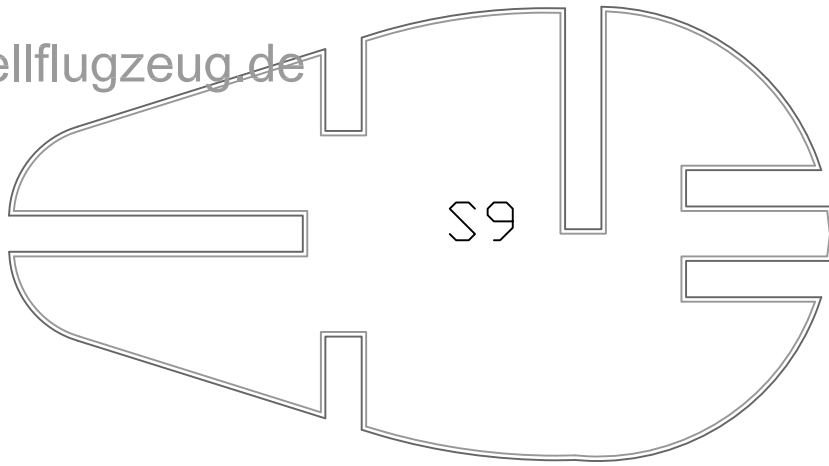

E2



H1



H2



E3



E1

Servo

Servo

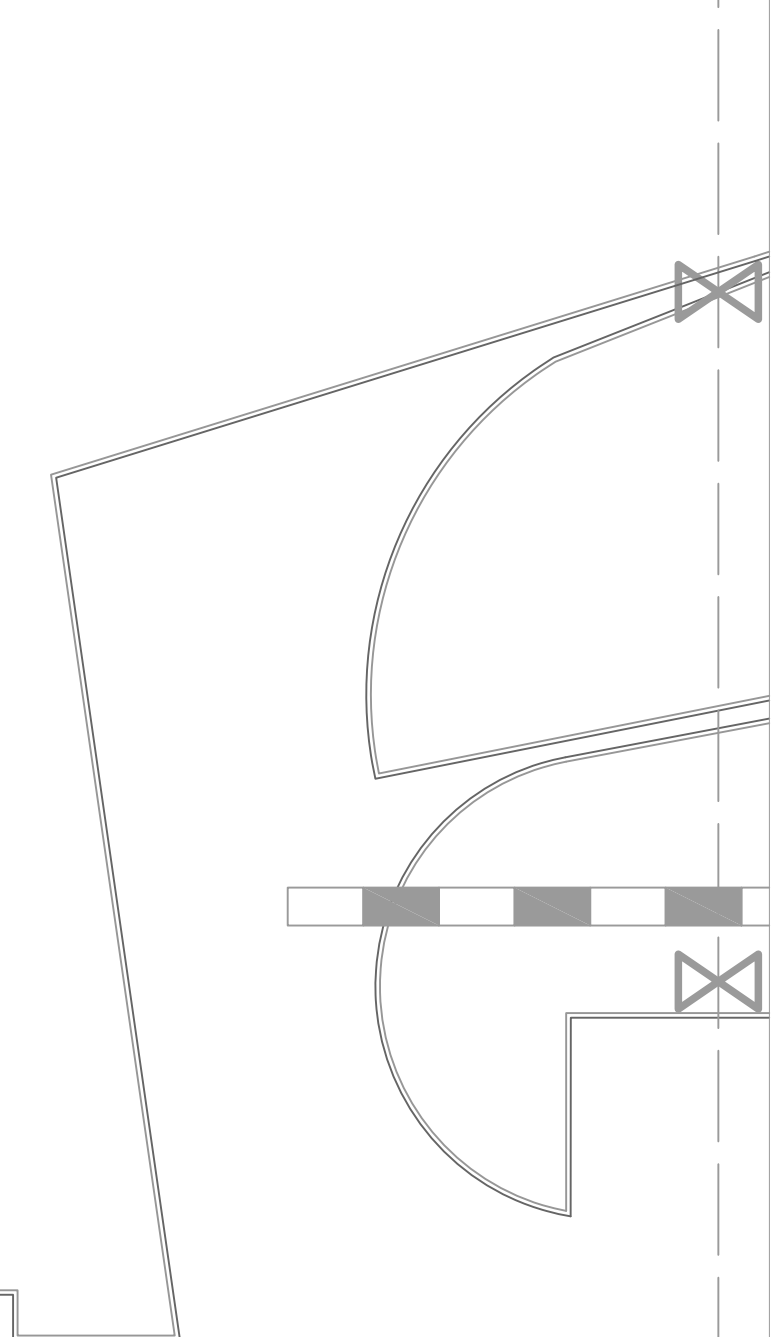
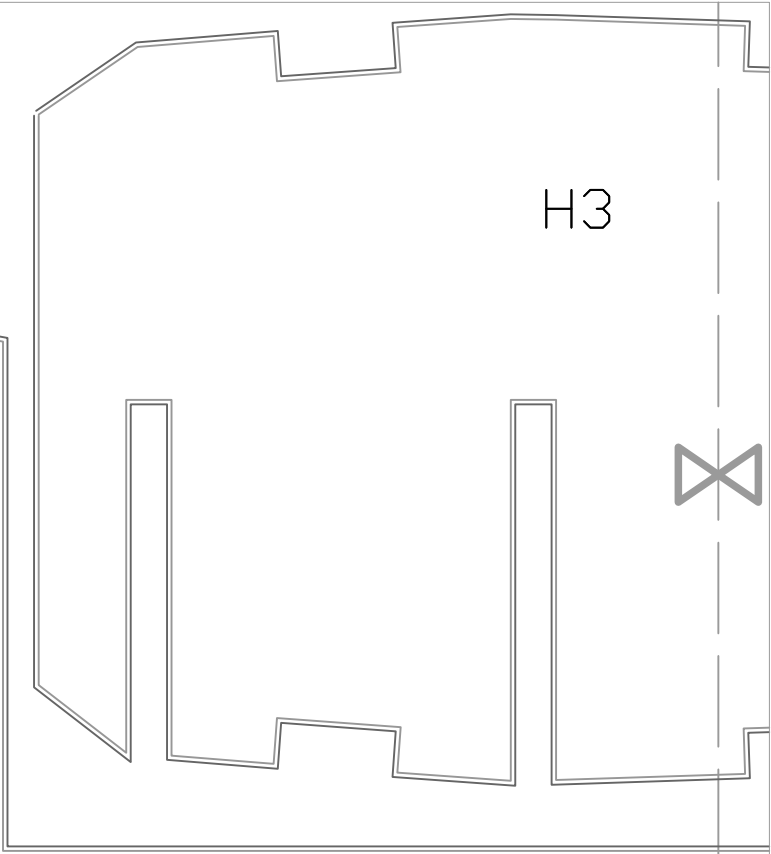
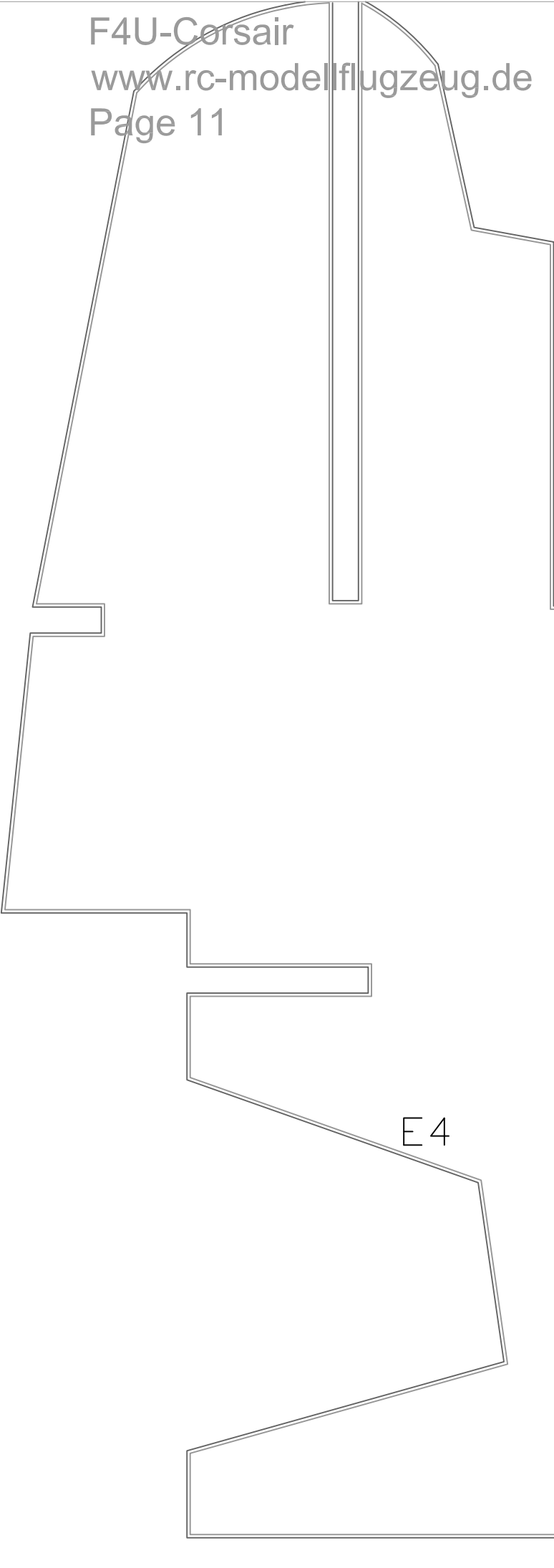

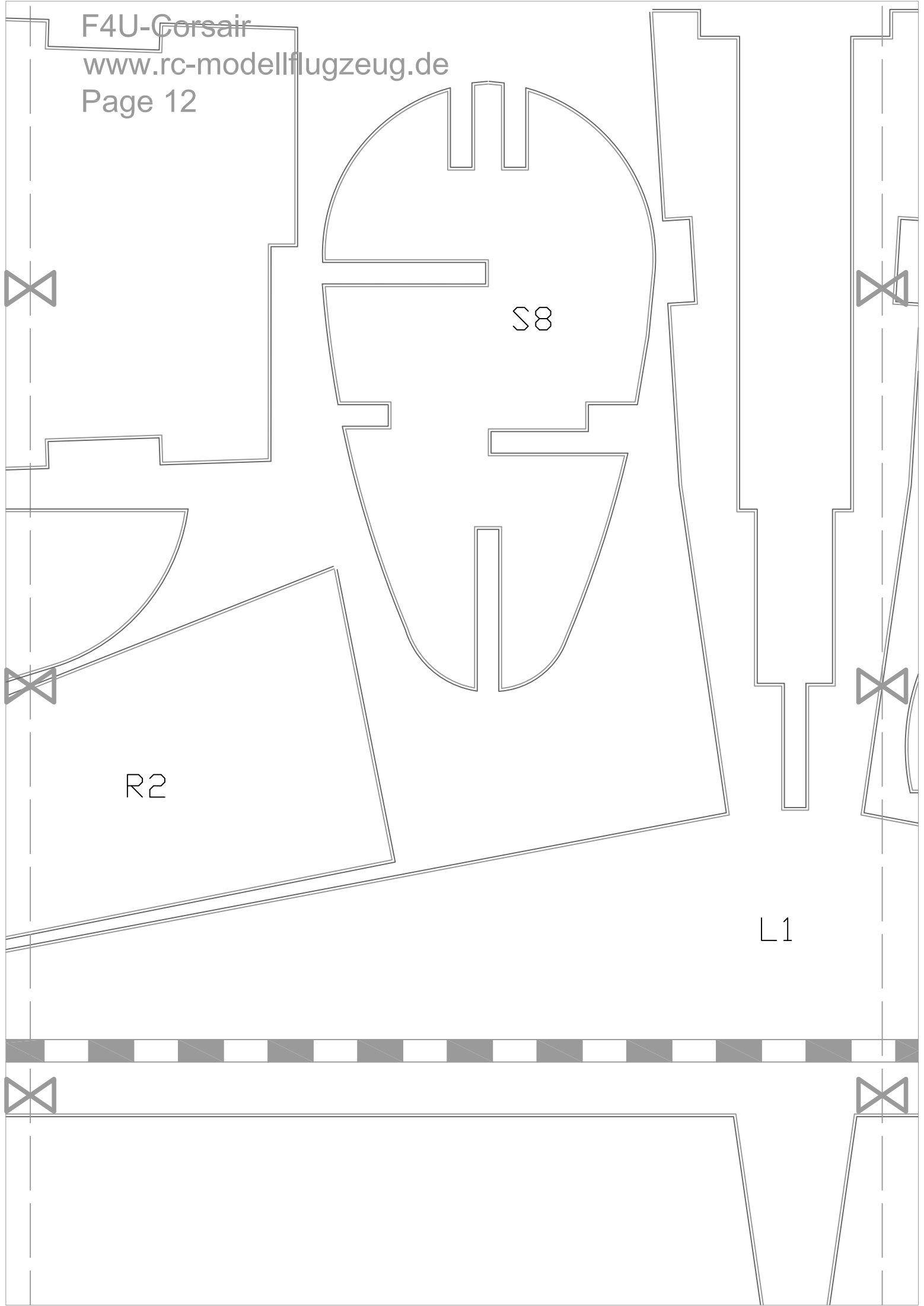

S8

R2

L1



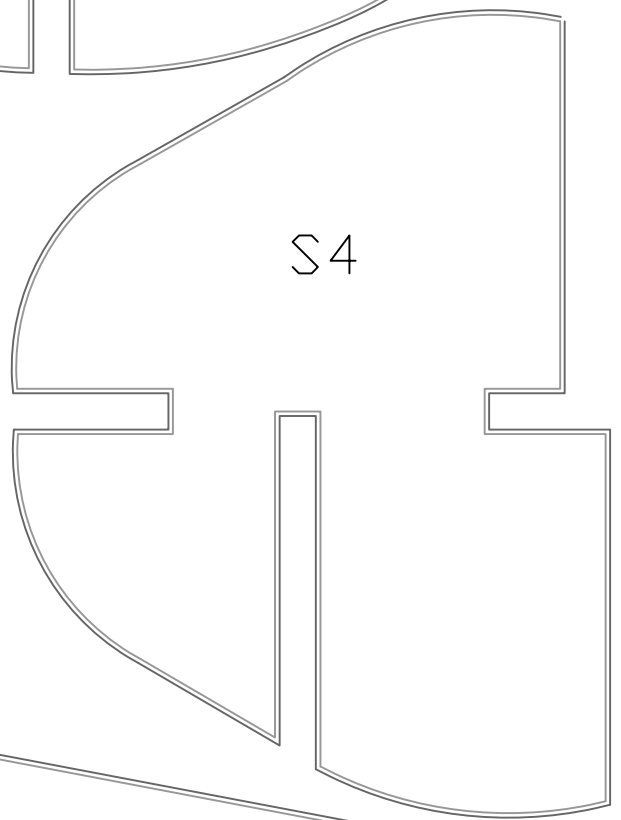
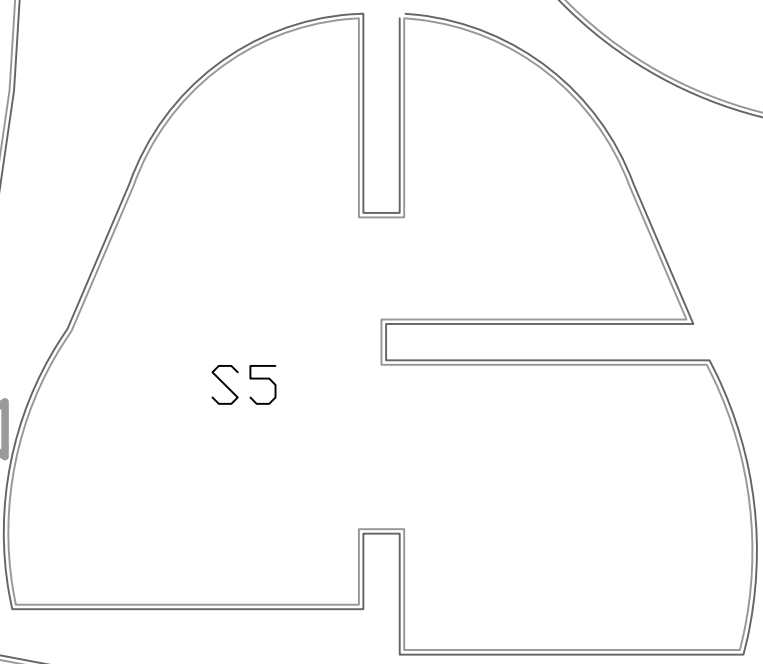
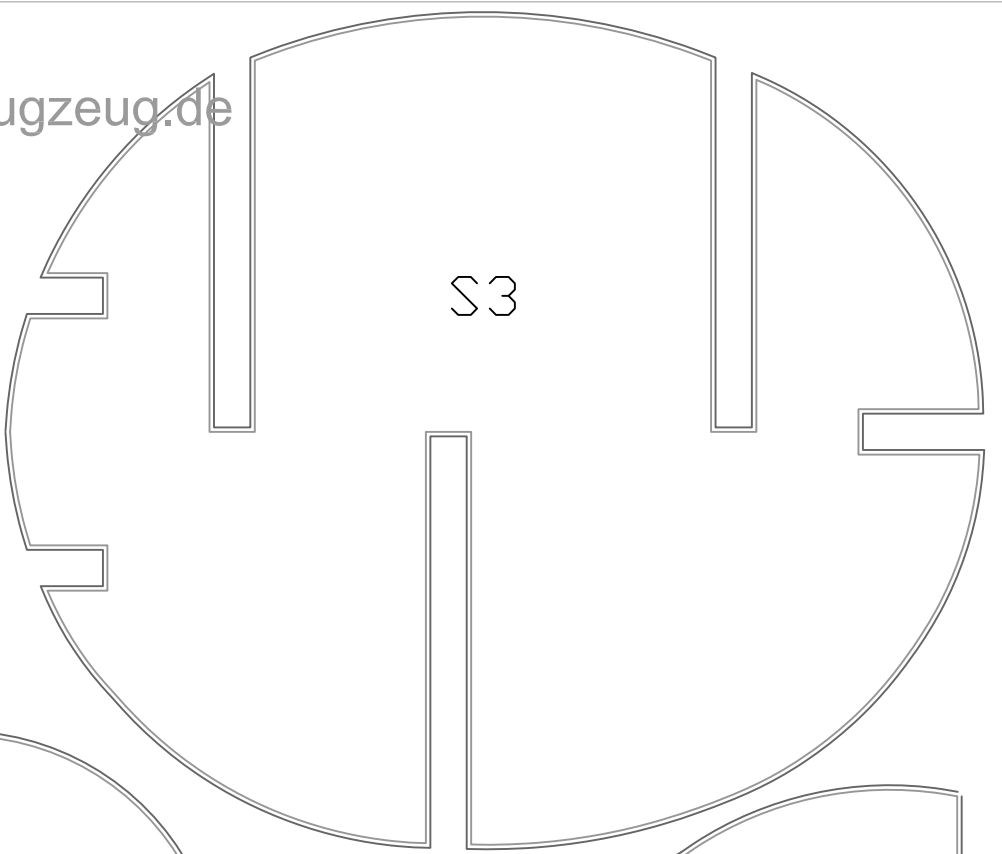
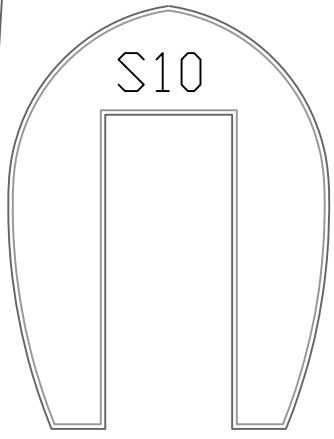

M3 (3mm Depron)



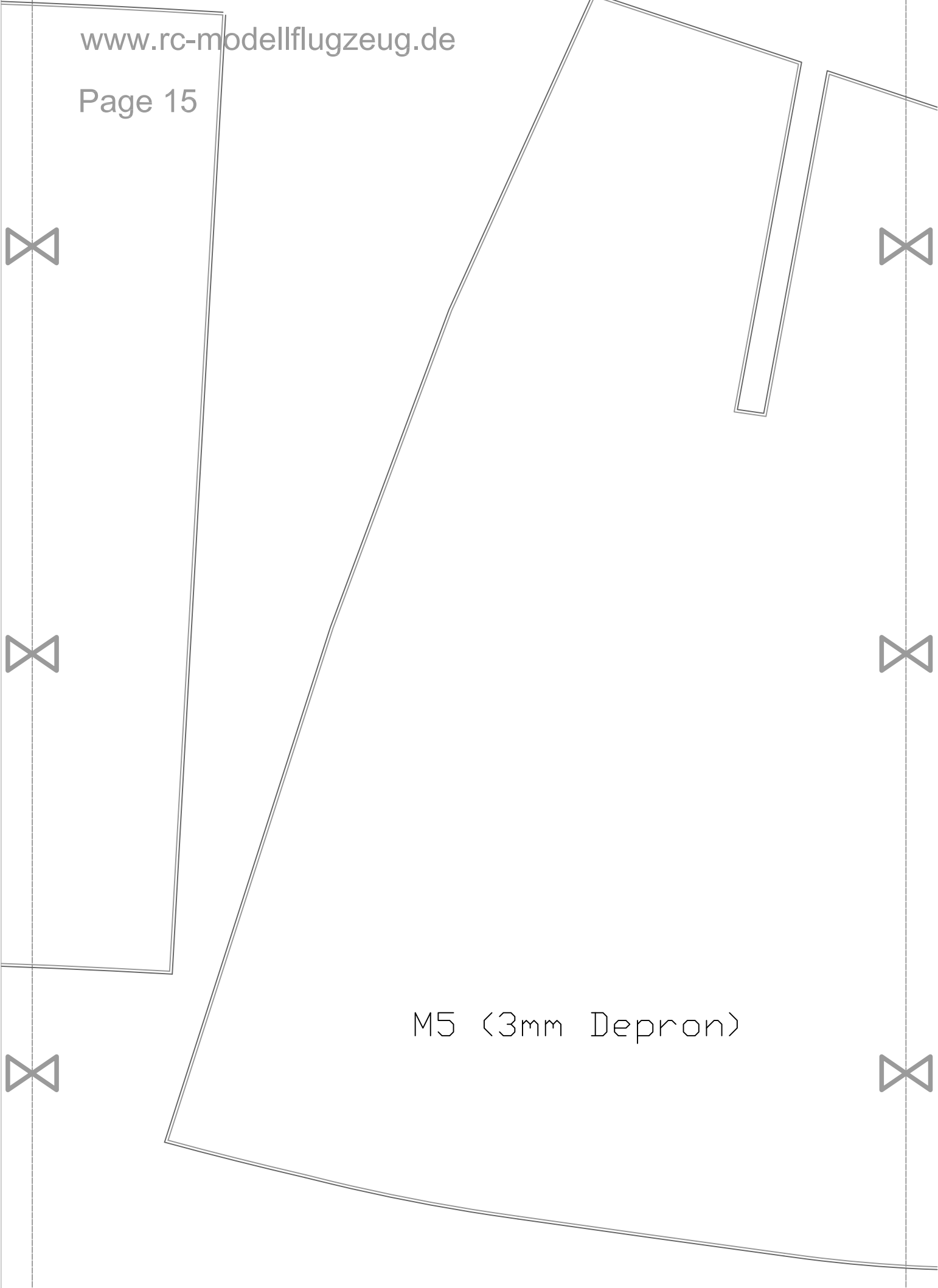

M5 (3mm Depron)

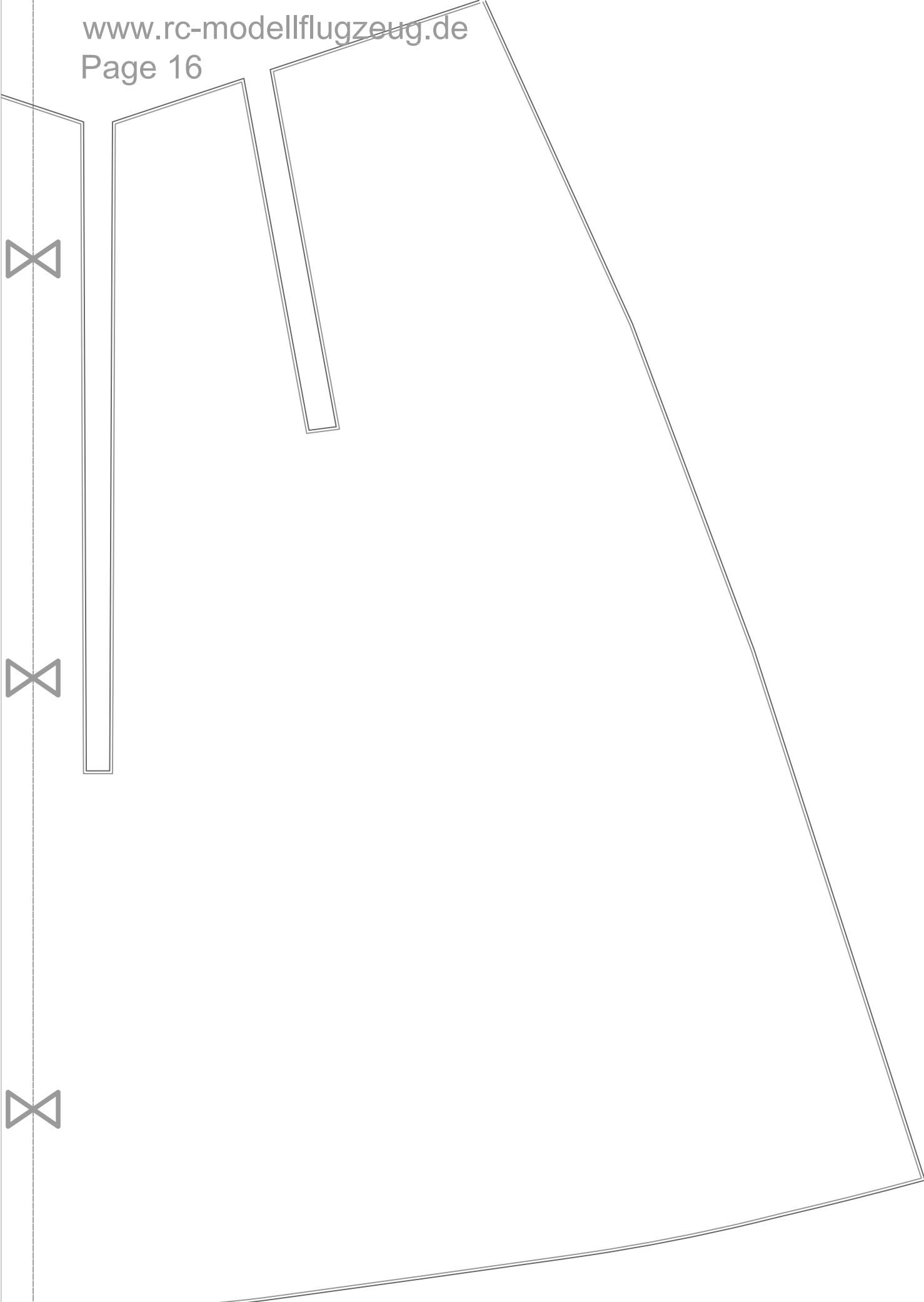

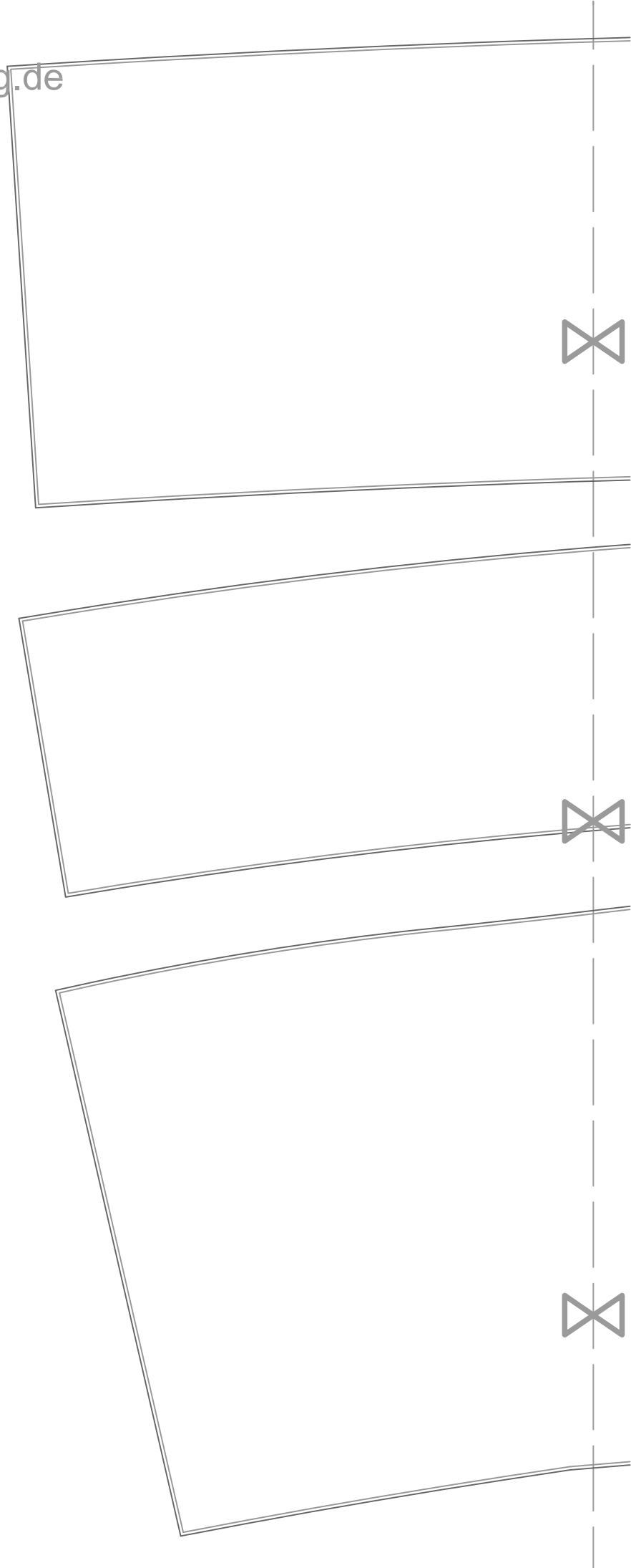



M2 (3mm Depron)



M1 (3mm Depron)



M4 (3mm Depron)





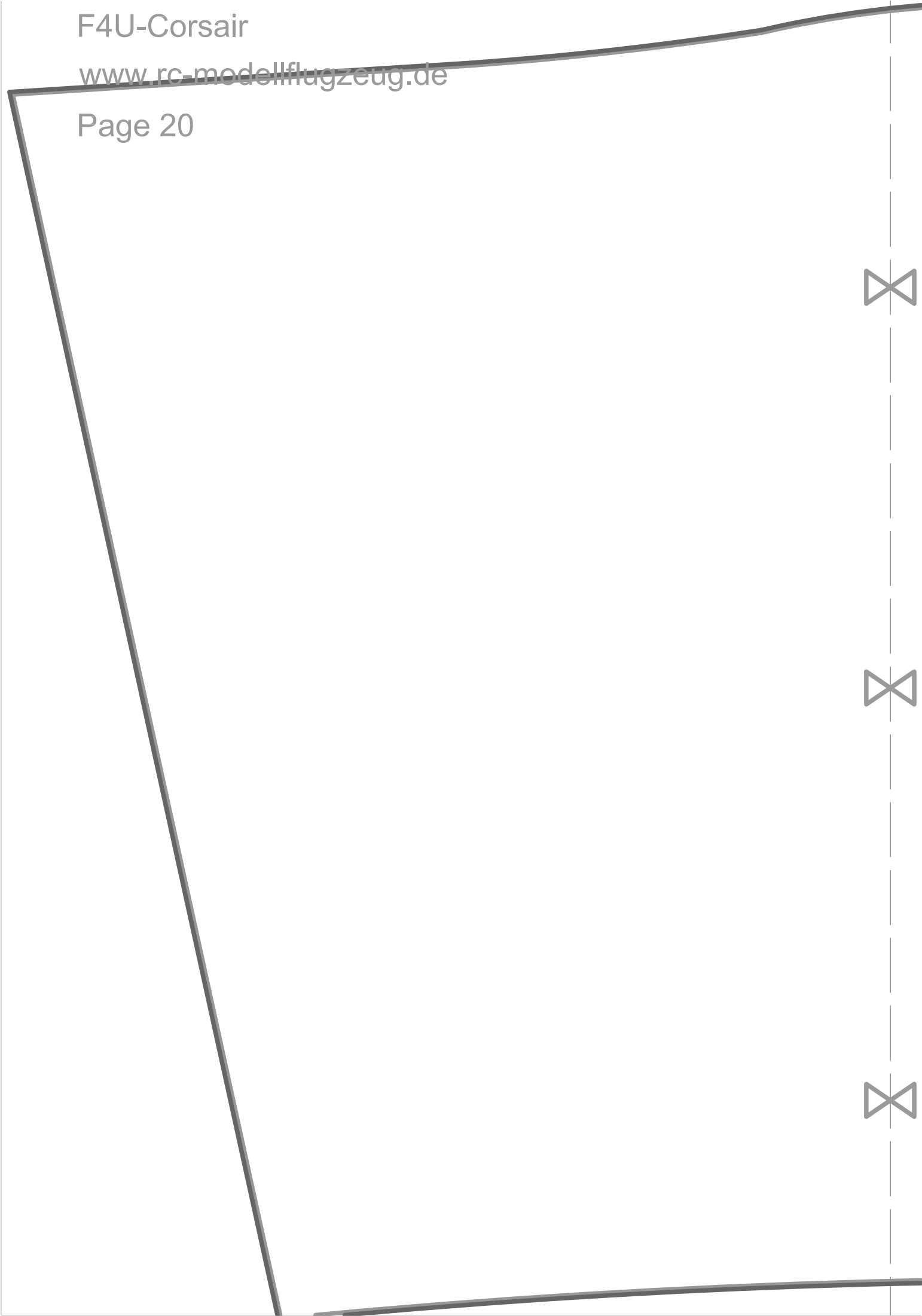

M6 (2x) (3mm Depron)



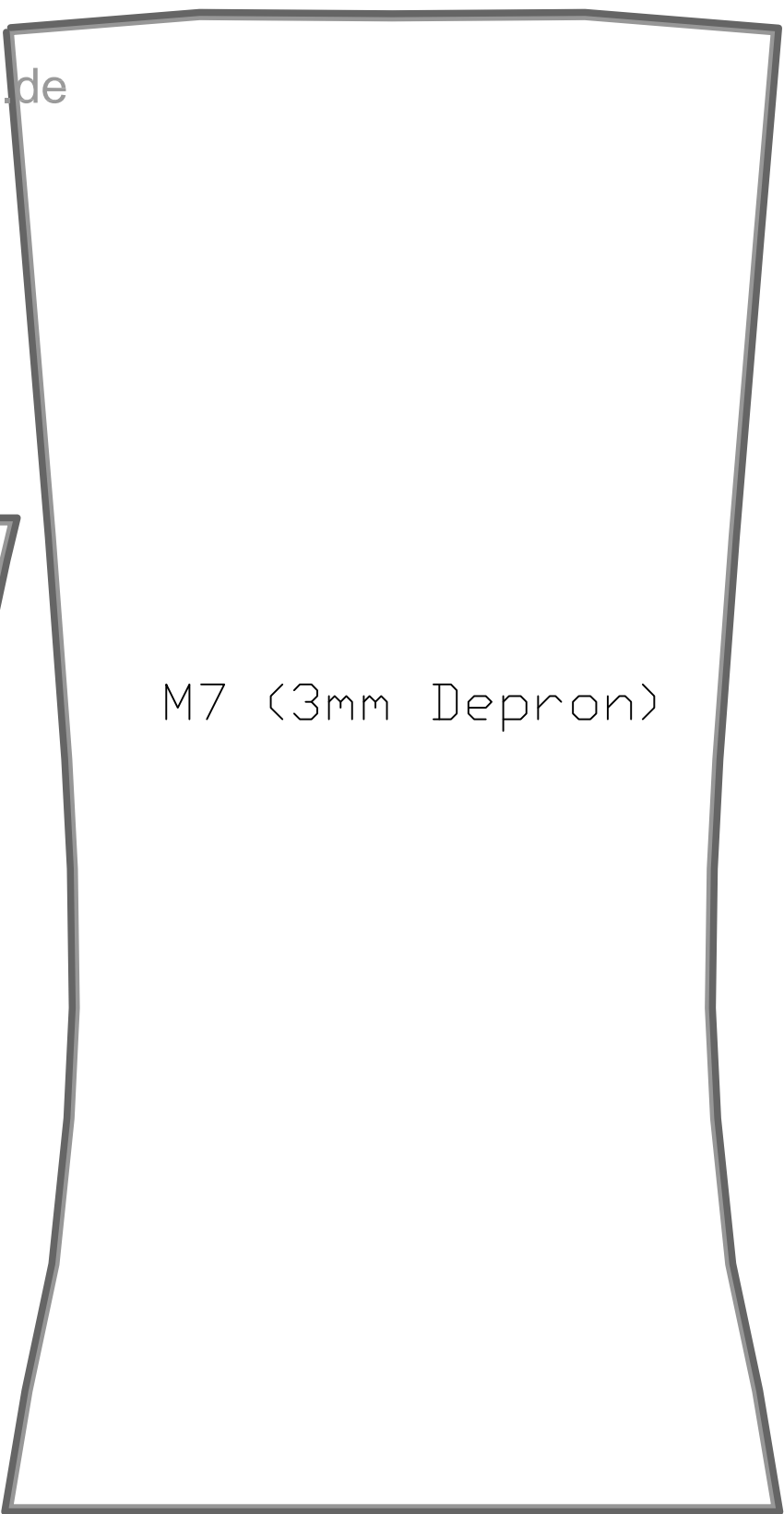

M7 (3mm Depron)

M8-A

M8-B

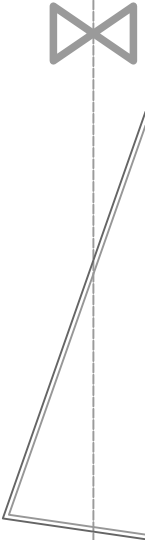

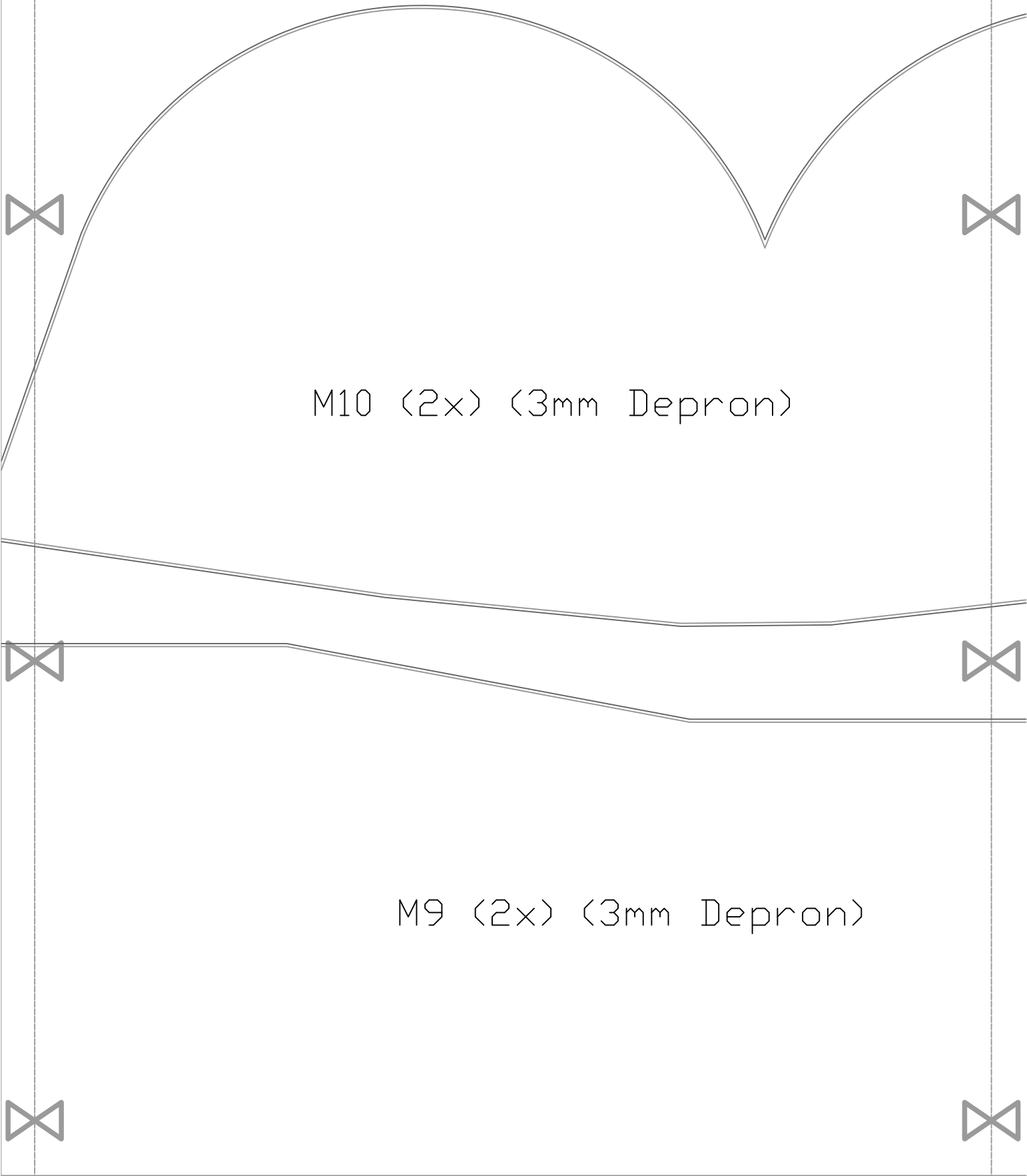

M10 (2x) (3mm Depron)

M9 (2x) (3mm Depron)

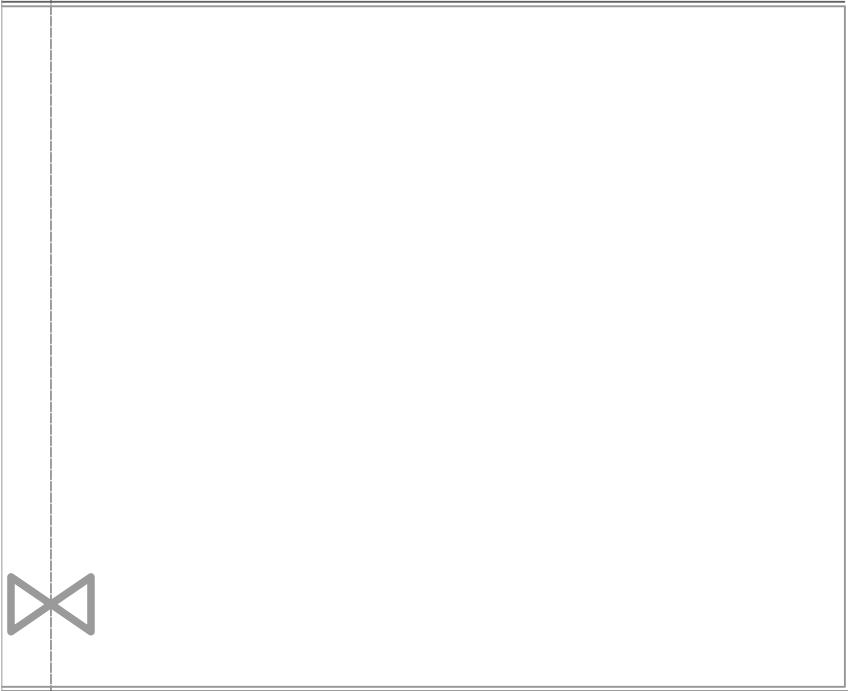
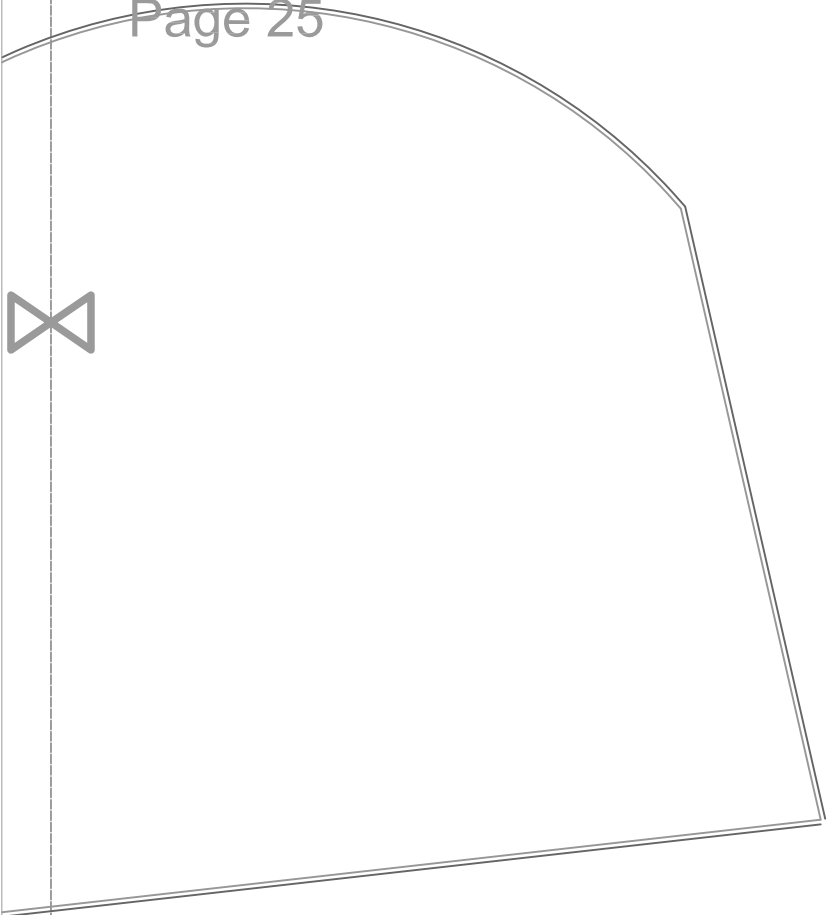

F

A

N

A

V

E

N

A

V



29

29

NAVY